

# Modular Housings for Hazardous Areas

**Knick** >

**IsoTrans® 36/37**



**For hazardous area/safe area isolation of 0 ... 20 mA standard signals without power supply.**

## The Task

Hazardous area normally means systems in continuous operation that require highly reliable components. The measurement signals need to be transmitted to the controller outside the hazardous area very accurately to control the processes optimally.

## The Problems

Often complex systems with power supplies are used for reliable hazardous/safe area isolation combined with electrical isolation to prevent measurement errors.

## The Solution

Knick loop-powered isolators for 0(4) ... 20 mA signal transmission. These devices are available as hazardous-area input and hazardous-area output isolators. Due to their patented design (German patent 3526997), they are considered to be the most reliable solution for isolating standard signals without external power supply.

## The Advantages

The IsoTrans® 36 and 37 isolators are not only suitable as highly reliable isolators for normal applications, they also meet the most extreme requirements that can be set for potential isolation. There is no need to wire the power supply.

## The Technology

The pioneering TransShield® technology allows specifications that previously could not be implemented:

- Extremely high reliability
- Safe Isolation, transient protection
- 10 kV test voltage (optional)
- High electromagnetic compatibility
- Extremely low residual ripple and common-mode interference
- Excellent pulse formation
- High transmission accuracy
- SMART transmission
- Hazardous/safe area isolation

In addition to the analog signals, they also transmit data protocols for SMART transmitters (HART®). They allow bidirectional communication from every point of the cabling.

**Special model available!  
Measure voltage without a power supply.**

Voltages in the range from 250 to 1200 V DC can be converted into current signals up to 5 mA using a special loop-powered version of the isolator. This allows, for example, the contact wire voltage to be checked easily. Please contact us if you need detailed information on this special model.

**Warranty  
5 years!**

*Defects occurring within 5 years from delivery are remedied free of charge at our works (carriage and insurance paid by sender).*

# Loop-Powered Isolators for Standard Signals

Isolation Amplifiers  
Transmitters

Indicators

Process Analytics

Portable Meters

Laboratory Meters

Sensors

Fittings



**Knick** >

## ■ The Facts

### Galvanic isolation between input and output signal

Protection against measuring errors caused by grounding problems and parasitic interference voltage

### No power supply required

Cost saving due to lower wiring effort, no mains influences

### Very low residual ripple

No interference of the connected measuring or control system

### Explosion protection according to ATEX

### High transmission accuracy

Excellent pulse formation due to exact transmission of measured values

### Very low common-mode interference

Avoiding incorrect measurements or failure due to interference signals

### Maximum reliability

No repair and failure costs

### 10 kV test voltage (optional)

### Safe Isolation according to EN 61140

Protection of maintenance staff and subsequent devices against non-permitted high voltages

### SMART transmission

Bidirectional point-to-point transmission of digital data according to HART® specification

### 5-year warranty

HART® is a registered trademark of the HART Communication Foundation



# Modular Housings for Hazardous Areas

## IsoTrans® 36/37

### ■ Product Line

Devices		Order No.
IsoTrans® 36	Input intrinsically safe	36 A7
IsoTrans® 37	Output intrinsically safe	37 A7
IsoTrans® 36 A9 special model	Passive voltage measurement, details on request	36 A9-xxx
<b>Power supply</b>		
None, supply from input signal		
<b>Options</b>		
Increased test voltage 10 kV AC		471

### ■ Specifications

Input data	36 A7	37 A7
Input <sup>1)</sup>	0 ... 20 mA, intrinsically safe	0 ... 20 mA
Operating current	≤ 20 µA	
Overload	50 mA	
Voltage drop	Approx. 4.5 V at 20 mA <sup>2)</sup>	Approx. 4 V at 20 mA
Output data	36 A7	37 A7
Output	0 ... 20 mA, max. 10 V (corresponds to 500 ohms load)	0 ... 20 mA, max. 20 V, intrinsically safe (corresponds to 1000 ohms load)
Load error	< 0.15 % meas. val. per 100 ohms load	
Offset	< 20 µA	
Residual ripple $V_{rms}$	< 10 mV at 20 mA and 500 ohms load	
Transmission behavior		
Transmission error	0.2 % meas. val.	
Rise or fall time	≤ 400 µs at 500 ohms load (10 ... 90 %, jump from 0 ... 20 mA or 20 ... 0 mA)	
HART® attenuation	<10 dB	

1) Linear transmission IsoTrans® 36: up to 50 mA, IsoTrans® 37: up to 22 mA

2) Approx. 8.5 V at 50 mA

# Loop-Powered Isolators for Standard Signals

Isolation Amplifiers  
Transmitters

Indicators

Process Analytics

Portable Meters

Laboratory Meters

Sensors

Fittings

**Knick** 

## Specifications (continued)

### Isolation

Test voltage	4.4 kV AC 10 kV AC with option 471
Working voltages (basic insulation)	3600 V AC/DC, 2500 V AC <sup>3)</sup> with overvoltage category II and pollution degree 2 according to EN 61010-1 For applications with high working voltages, you should ensure there is sufficient spacing or isolation from neighboring devices and protection against electric shocks. Permissible working voltages for other overvoltage categories and pollution degrees on request. For hazardous area applications the maximum working voltage is 250 V.
Protection against electric shock	Safe Isolation according to EN 61140 by reinforced insulation in accordance with EN 61010-1. Working voltages with overvoltage category II and pollution degree 2: 600 V AC/DC. For applications with high working voltages, you should ensure there is sufficient spacing or isolation from neighboring devices and protection against electric shocks. For hazardous area applications the maximum working voltage is 250 V.

### Standards and approvals

	36 A7	37 A7
Explosion protection	II (1) G [EEx ia] IIC, input intrinsically safe PTB 02 ATEX 2134 For further specifications, refer to EC-Type-Examination Certificates.	II (2) G [EEx ib] IIC, output intrinsically safe PTB 02 ATEX 2063
EMC <sup>4)</sup>	European EMC regulations according to 89/536/EEC directive NAMUR NE 21, EN 61326	

### Other data

Ambient temperature	Operation: -10 ... +50 °C Transport and storage: -30 ... +80 °C
Design	Modular housing, width 22.5 mm, screw terminals, See dimension drawings for further measurements
Ingress protection	Housing IP 20, terminals IP 20
Mounting	With snap-on mounting for 35 mm top hat rail according to EN 50022, see dimension drawings for conductor cross section
Weight	Approx. 120 g

<sup>3)</sup> For circuits according to table 6 from EN 61010-1 (transient overvoltage 2600 V)

<sup>4)</sup> In the 1 ... 20 mA range

# Modular Housings for Hazardous Areas

## IsoTrans® 36/37

### ■ Block Diagrams

#### IsoTrans® 36 A7

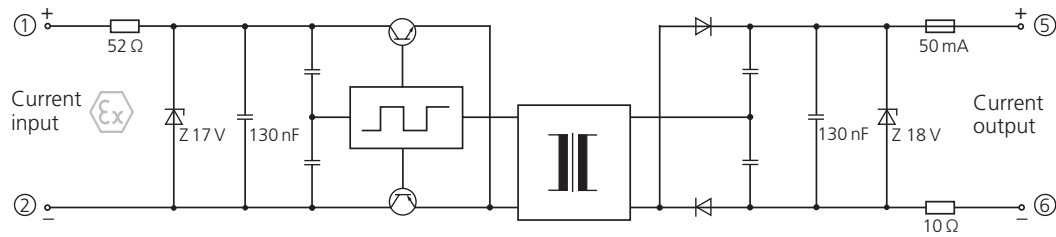

#### IsoTrans® 37 A7

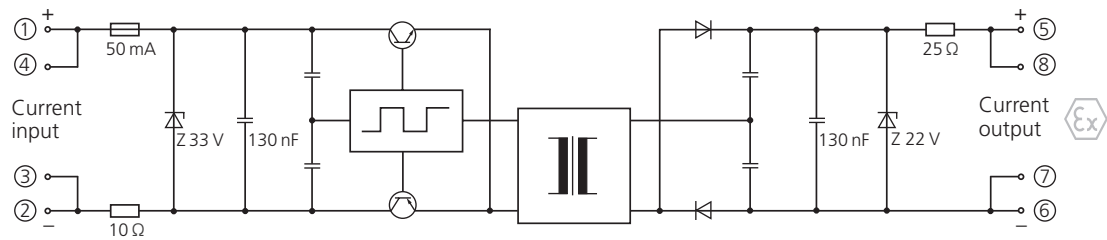

# Loop-Powered Isolators for Standard Signals



## Application Examples IsoTrans® 36 A7

### Without HART® communication

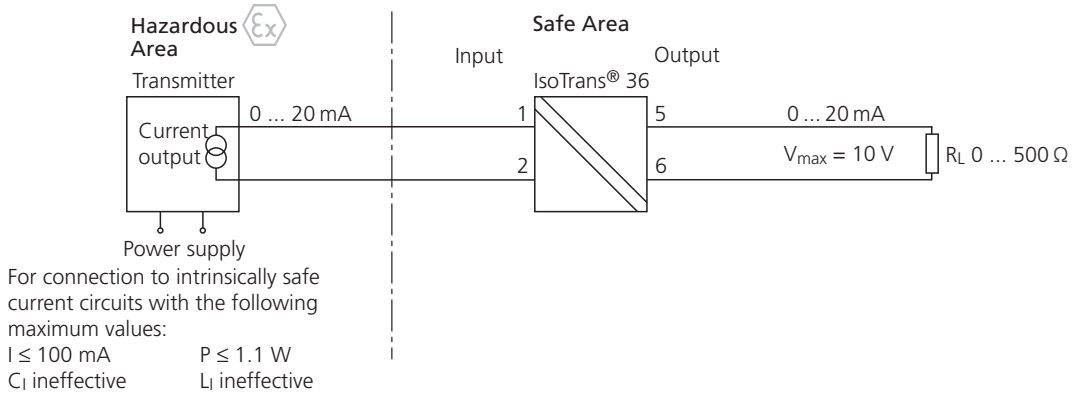

### With HART® communication

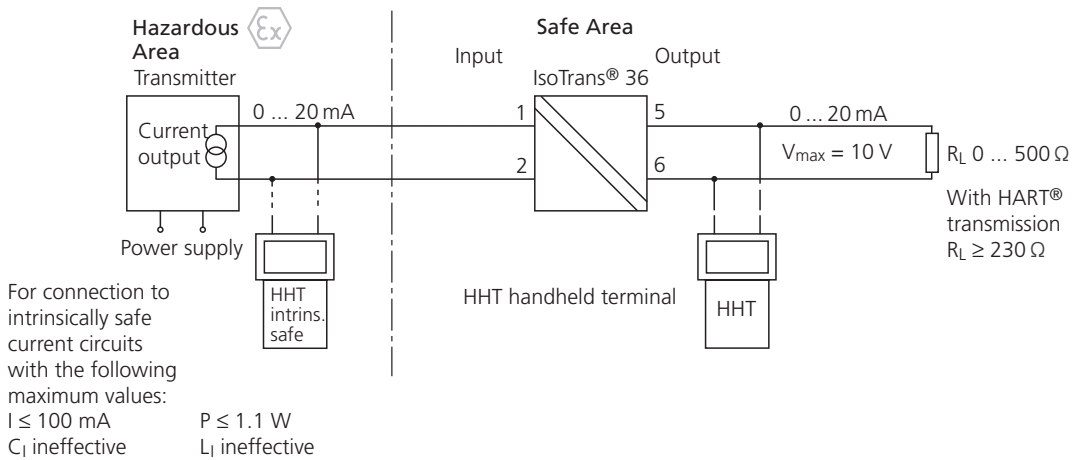

# Modular Housings for Hazardous Areas

## IsoTrans® 36/37

### Application Examples IsoTrans® 37 A7 (continued)

#### Without HART® communication

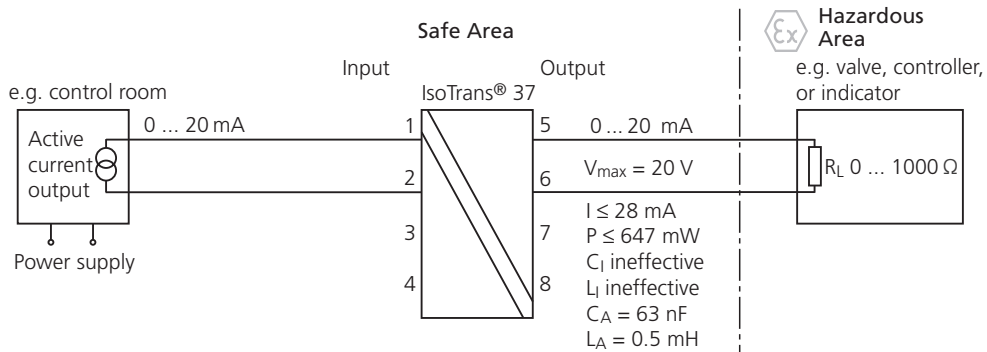

#### With HART® communication

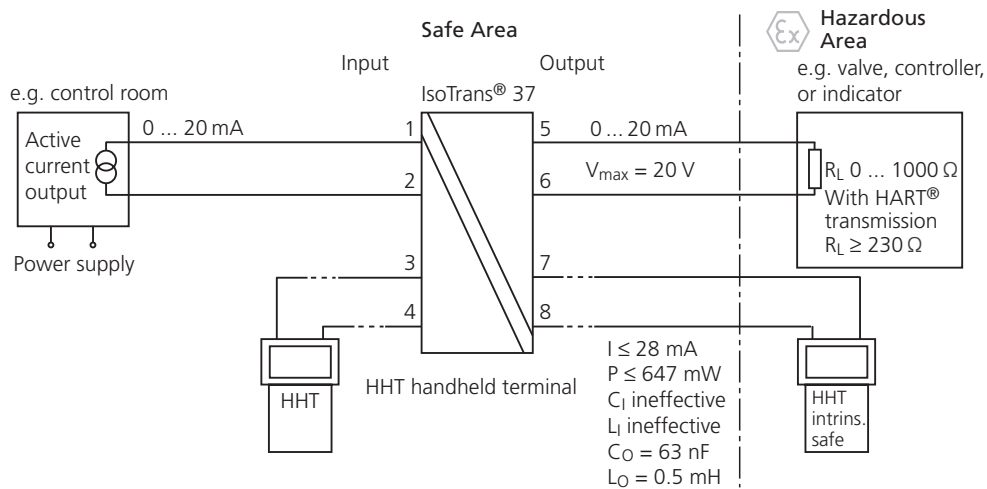

# Loop-Powered Isolators for Standard Signals

Isolation Amplifiers  
Transmitters

Indicators

Process Analytics

Portable Meters

Laboratory Meters

Sensors

Fittings

## Knick >

### ■ Dimension Drawings and Terminal Assignments

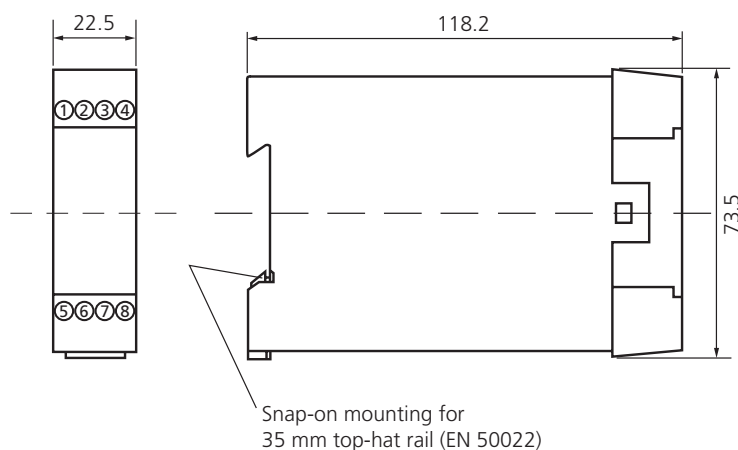

#### IsoTrans® 36 A7

- 1 Input +
- 2 Input -
- 5 Output +
- 6 Output -

#### IsoTrans® 37 A7

- 1 Input +
- 2 Input -
- 3 HHT non-intrinsically safe
- 4 HHT non-intrinsically safe
- 5 Output +
- 6 Output -
- 7 HHT intrinsically safe
- 8 HHT intrinsically safe

HHT = handheld terminal

Captive M3x8 clamping screws, box terminals with self-releasing wire protection, max. conductor cross-section  
1 x 4 mm<sup>2</sup> solid; 1 x 2.5 mm<sup>2</sup> stranded with ferrule;  
2 x 1.5 mm<sup>2</sup> stranded with ferrule

Installation, commissioning, and maintenance  
may be carried out only by trained personnel!

All dimensions in mm!